

陶齋吉金錄

陶齋吉金錄卷五目錄

秦重金壘

秦郃宮盃

秦乃

秦右殊鼎

宜陽鼎

尔甘里鼎

永里鼎

衙鼎

寇公鼎

上官鼎

漢府鼎

西鼎

雖鼎

盩屋鼎一

盩屋鼎二

濕成鼎
犛車宮鼎
中水鼎
汝陰鼎
平陽鼎
長楊鼎
荀少夫鼎
壽成鼎

長安鼎

大衛無極鼎蓋

秦高都劍

鄭武軍斷劍

官率劍

陰平劍

帛平侯劍

漢黃龍劍

宜富劍格

踏螭劍

秦寺工殘戈

武庫戈

八羗戈

左將戈

漢武子戈

造戈

秦重金罍

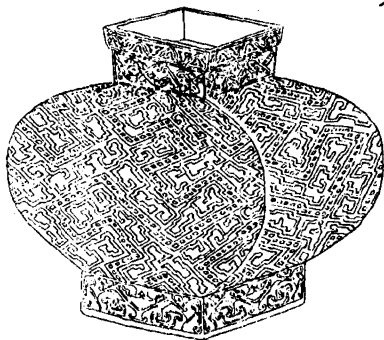

右高八寸七分深七寸三分口徑
三寸七分腹徑七寸八分底徑三
寸九分

秦邵宮壺

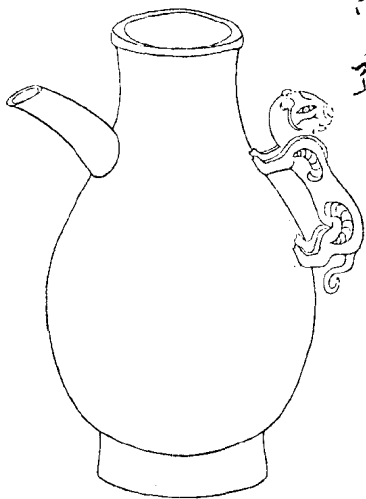



右高一尺五寸二分深一尺四寸六分
口徑五寸三分腹徑一尺五寸流四
寸四分虎身長五寸五寸高二寸
六分

秦
瓦
原形

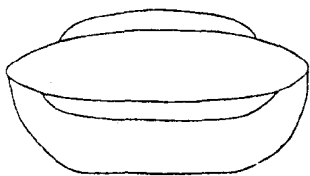

陰齋吉金錄



三

秦右殊鼎

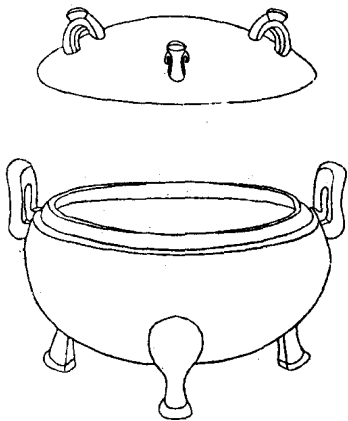

右高五寸七分深四寸四分口徑
七寸腹徑八寸九分耳高二寸五
分濶一寸四分蓋高一寸八分徑八
寸三分



耳



耳

秦宜陽鼎

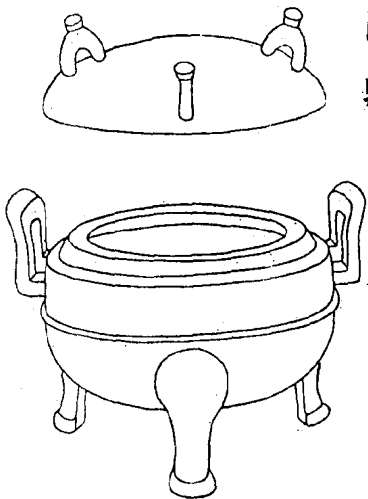

二尺几寸
廿二

盖

陽宜

十三寸

二尺八寸

器

右高七寸四分深五寸五分口径
七寸八分腹徑一尺三分耳高三
寸一分濶二寸一分盖高二寸二分
徑八寸九分

秦尔甘里鼎

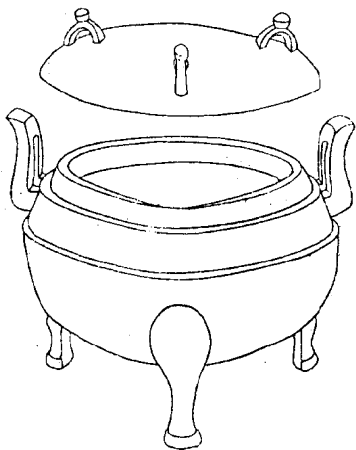

右高六寸八分深四寸九分口徑
六寸八分腹徑九寸耳高二寸三
分濶一寸九分蓋高一寸徑八寸
六分



蓋

秦永里鼎

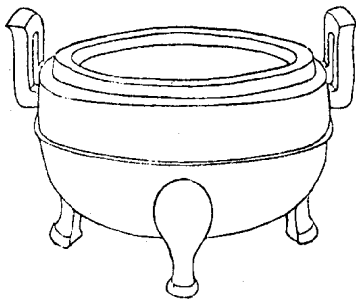
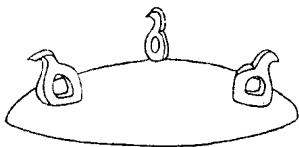



器

右高六寸七分深五寸七分口徑
七寸五分腹徑九寸九分耳高二
寸八分潤二寸蓋高二寸徑九寸
五分

秦 衛 鼎

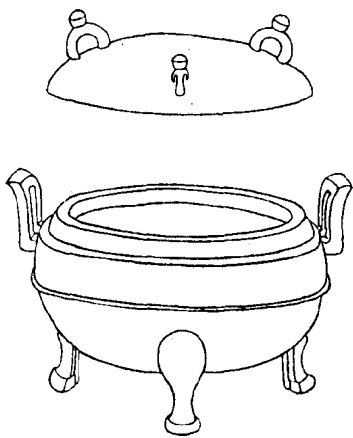



蓋

右高五寸五分深四寸三分口徑
五寸七分腹徑八寸三分耳高二
寸二分濶一寸四分蓋高一寸四分
徑七寸五分

秦冠公鼎

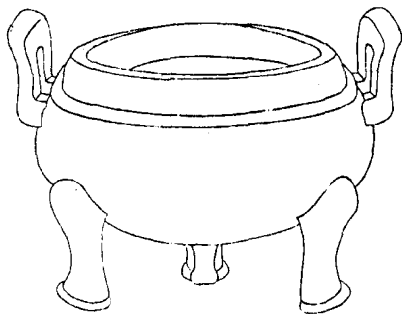



耳



腹

右高五寸二分深四寸八分口徑六寸四分腹徑八寸五分耳高二寸六分濶一寸五分

秦上官鼎

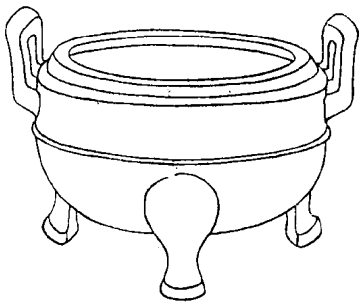

器



右高六寸一分深五寸二分口徑七寸六分腹徑七寸六分耳高二寸八分潤二寸三分蓋高二寸徑九寸一分

漢府鼎

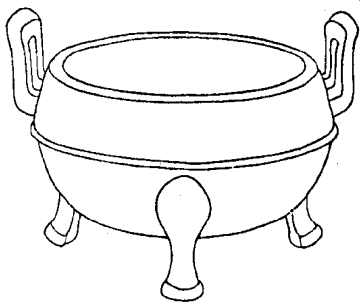



器

右高五寸九分深四寸八分口徑
九寸一分耳高二寸濶一寸七分

漢西鼎

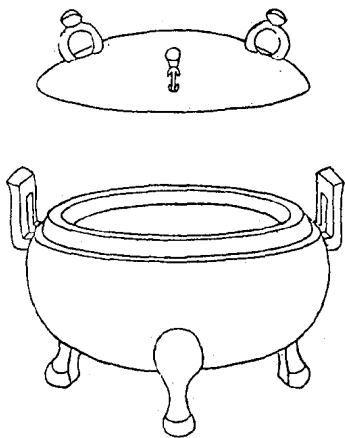



器

蓋

右高五寸二分深四寸三分口徑六寸一分腹徑七寸九分身高一寸八分潤一寸一分蓋高一寸五分徑七寸六分

漢 羅鼎

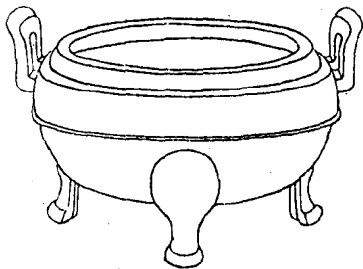
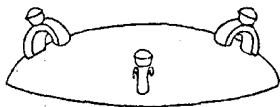



器

右高六寸一分深四寸四分口徑
六寸一分腹徑六寸耳高二寸五
分潤一寸一分蓋高一寸四分徑

六寸六分

漢 盨 屋 鼎 一

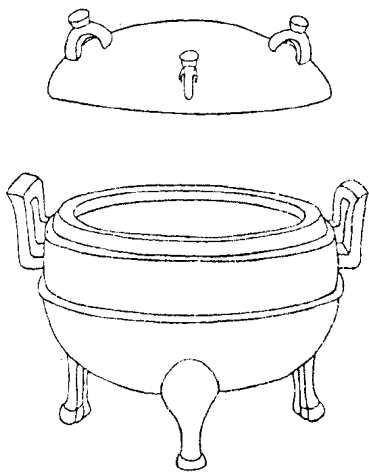



蓋



器



器

右高八寸八分深五寸一分口徑
一尺一寸六分腹徑一尺三寸三
分耳高三寸潤二寸一分蓋高
二寸五分徑一尺二寸八分

陽春言全

一

漢 蓋 屋 鼎 二

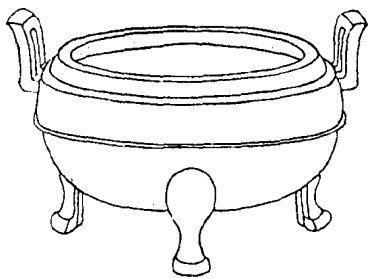

右高五寸七分深四寸三分口徑五寸八分腹徑八寸二分耳高二寸一分潤一寸四分蓋高一寸四分徑七寸六分



器



器



蓋



蓋

漢濕成鼎

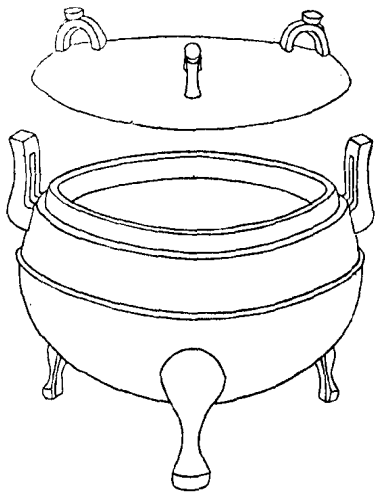



蓋



器

右高七寸四分深五寸七分口徑八寸八分腹徑一尺五分耳高二寸一分潤一寸八分蓋高二寸一分徑一尺

漢犂車宮鼎

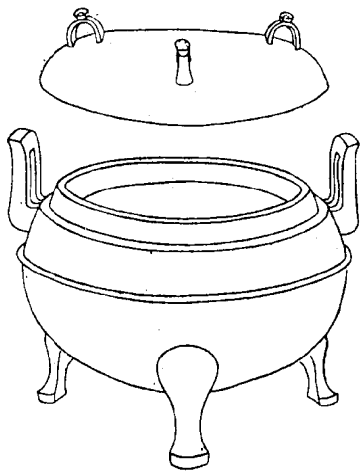

右高五寸八分深四寸六分口徑六寸
二分腹徑六寸九分耳高二寸二分潤
一寸六分蓋高二寸二分徑六寸七分



蓋



器

漢中水鼎

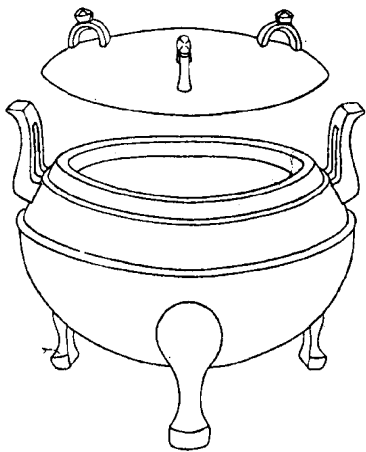

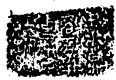

器

右高六寸深四寸二分口徑六寸
七分腹徑八寸二分耳高二寸一分
潤一寸五分蓋高一寸三分徑七分
七分

漢汝陰鼎

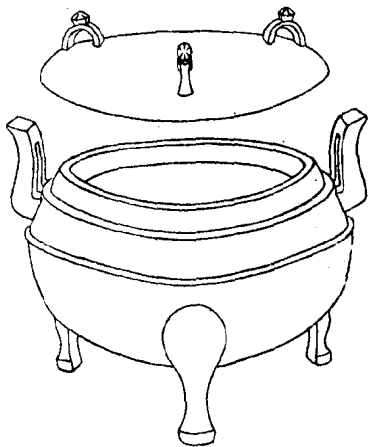



器

右高六寸六分深四寸七分口徑
七寸四分腹徑八寸八分耳高二
寸一分濶一寸六分蓋高二寸徑
八寸四分

漢平陽鼎

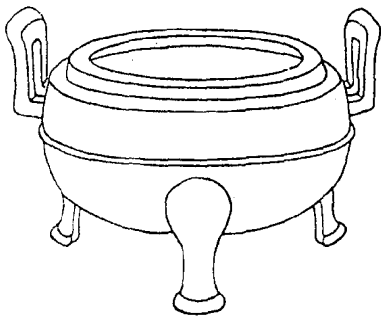
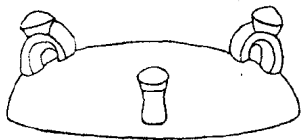

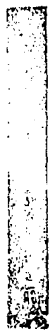

蓋

右高五寸六分深四寸七分口徑
六寸七分耳高二寸五分濶一寸
五分蓋高一寸八分徑八寸三分

漢長楊鼎

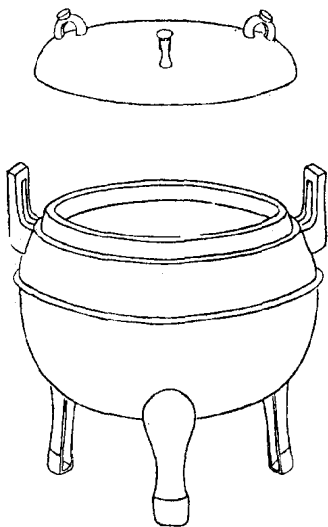

陽明先生全集卷之十一

陽明先生全集

器



右高六寸六分深四寸三分腹
徑七寸三分耳高二寸五分濶
一寸二分蓋高一寸五分徑六
寸七分

漢荀少夫鼎

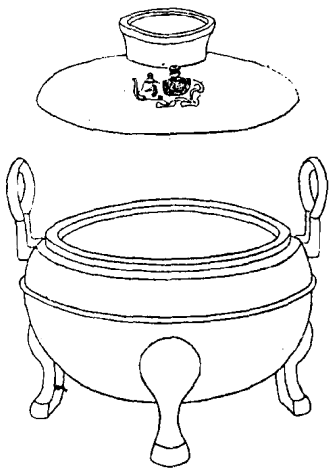



蓋



器

右高一尺一寸二分深九寸三分口
徑一尺四寸五分腹徑一尺七寸九
分耳高四寸四分潤四寸蓋高四
寸徑一尺五寸八分

漢壽成鼎

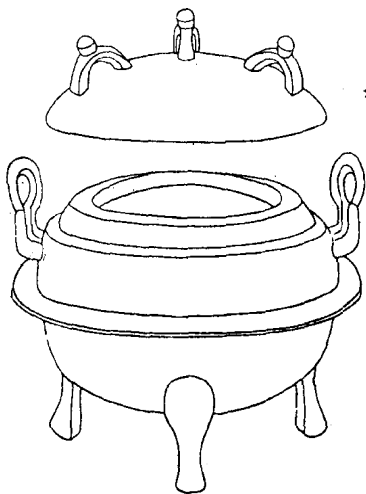

蓋



器





右高七寸二分口徑六寸腹徑
八寸一分耳高二寸二分濶一寸

六分蓋高一寸五分徑七寸七分

漢長安鼎

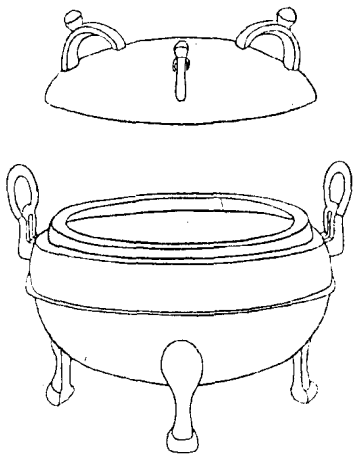

長圓圓蓋成廟銅三毛鼻蓋二合第九

蓋

圓蓋成廟銅鼻周三毛二合并重十三斤六兩通平三
季十月王王(夏)造屋承軸掾譚同合累然道第九

器

右高六寸五分深四寸六分口徑
六寸五分腹徑七寸二分耳高二
寸七分潤二寸二分蓋高一寸五分
徑八寸八分

漢大衛無極鼎蓋



右高一寸三分徑五寸八分



秦高都劍



廿九年高祖命陸賈使南越

右通長一尺七寸九分

秦鄭武軍斷劍





右通長一尺二寸三分

秦官率劍





右通長一尺九寸

秦陰平劍





右通長一尺九寸七分

秦 帛 牙 侯 劍





右通長一尺一寸五分

漢黃龍劍





右通長一尺九寸八分

漢宜富劍格原形

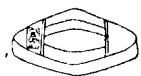



漢蟠螭劍





右通長一尺九寸四分



秦武庫戈 原形

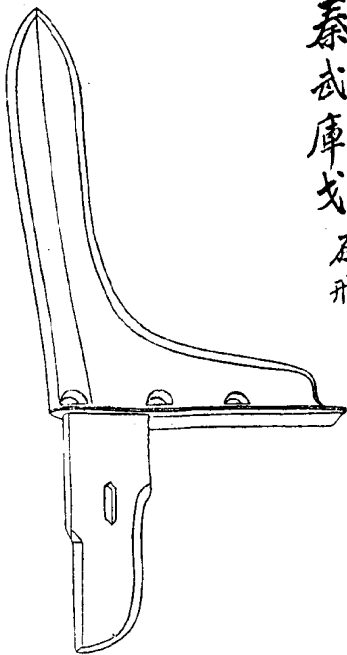

王三才
商司
武庫天
司

共

秦八羗戈原形

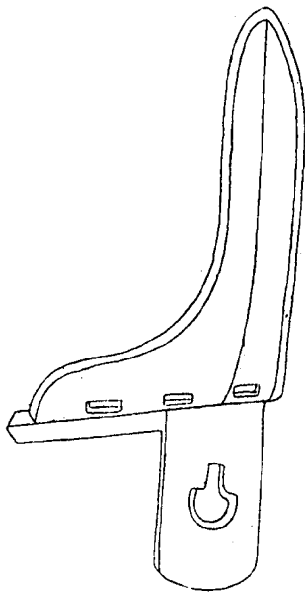

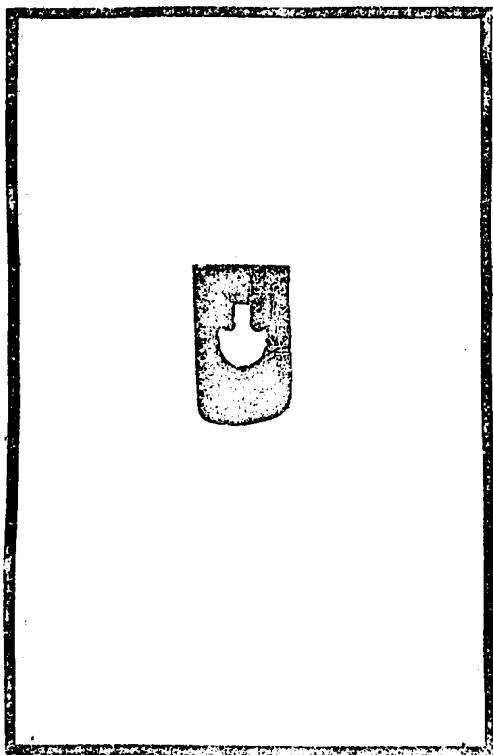

秦左將戈 原形

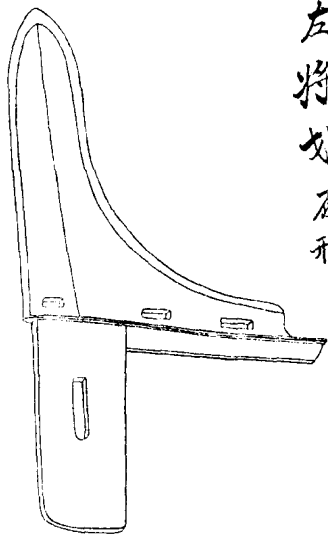

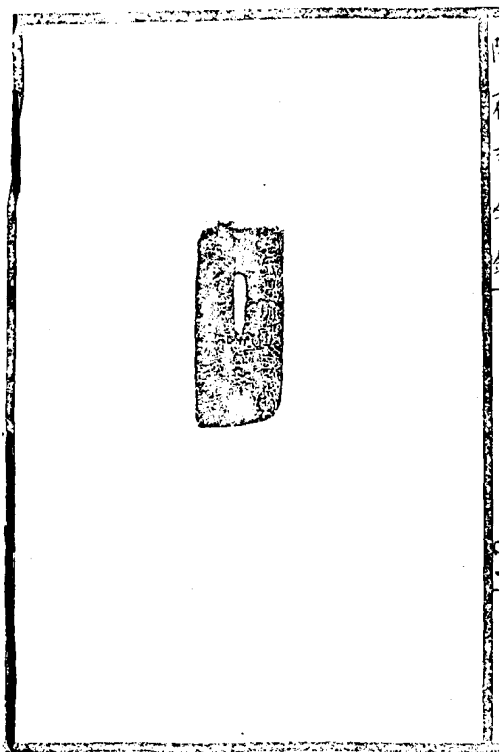

漢武子戈原形

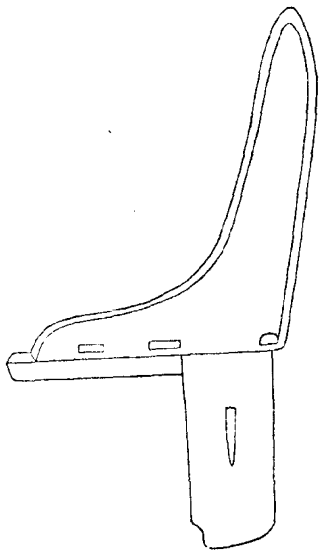

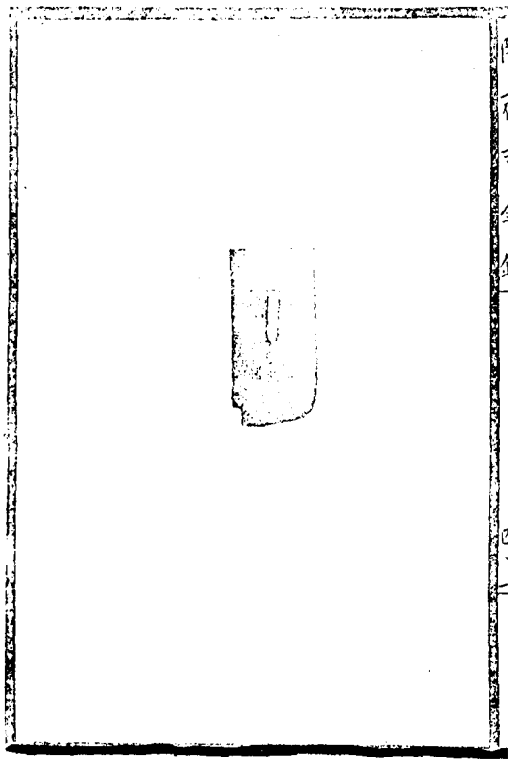

漢造戈原形

